

Product Overview

Energy efficient DC brushless motor with micro processor technology that soft starts at very low in-rush current, which works well with Tegpro's Pump Controller. The durable permanent magnetic rotor/impeller and fine ceramic shaft employ advanced magnetic drive technology with a static-impeller, that never leaks. Long lasting brushless pump, ideal for a 30,000 hour lifetime that can sustain continual 24 hour operation. Automatic overload, over-temperature, and dry-run protection.



Specifications

- Voltage: 6V~24V DC (Standard:12V DC)
- Max Flow Rate: 2.25 G/Min
- Max Water Head: 4.6 Ft
- Brass 1/2" BSP / NPT male Inlet/Outlet
- Ideal Life Time: 30,000 Continuous
- Max working temperature: 110°C (230° F)
- Protection Features: Over-Load, Over Current & Reverse Polarity
- Noise : ≤45dB far from 1m distance

Applications

The Tegpro TEG water cooling pump can be used for circulating water through baseboard heaters, radiant tubing & radiators. It can also circulate heated water to a hot water storage tank. The long lasting brushless motor technology provides maintenance free and quiet service life. This pump is perfect for carrying hot water away from thermoelectric generators systems or TEG/Solar hybrid systems.

Features

The Tegpro TEG water cooling pump has a soft start-up feature and cycling due to unsuccessful attempts is minimized. Even after prolonged shutdown, the pump will start reliably. The pump comes with an integrated over-temperature safety device which shuts off the pump when it exceeds 110°C (230°F). It will resume normal operation when the temperature goes below 95°C (203°F). The temperature of the electronic components is influenced by the temperature of the pumped media as well as by the speed setting. When the pump reaches 95°C (203°F) it will lower its speed automatically in order to avoid a total shutdown.

Materials of Construction (Wetted Parts)

- Hi-Temp Ryton Plastic- PPS (food grade)
- Brass Inlet/Outlet
- Viton "O" Ring
- Hi-Temp Ryton (PPS) Impeller
- Ceramic Ferrite Magnet

Tegpro Water Pump Curves

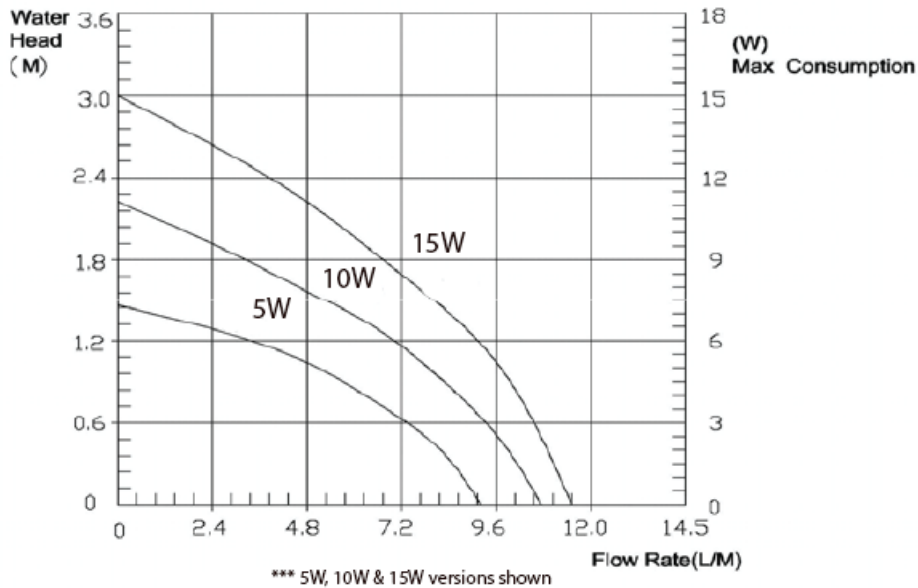

Dimensional Drawings For TE-PUMP-5W-12V

All dimensions in mm unless rated

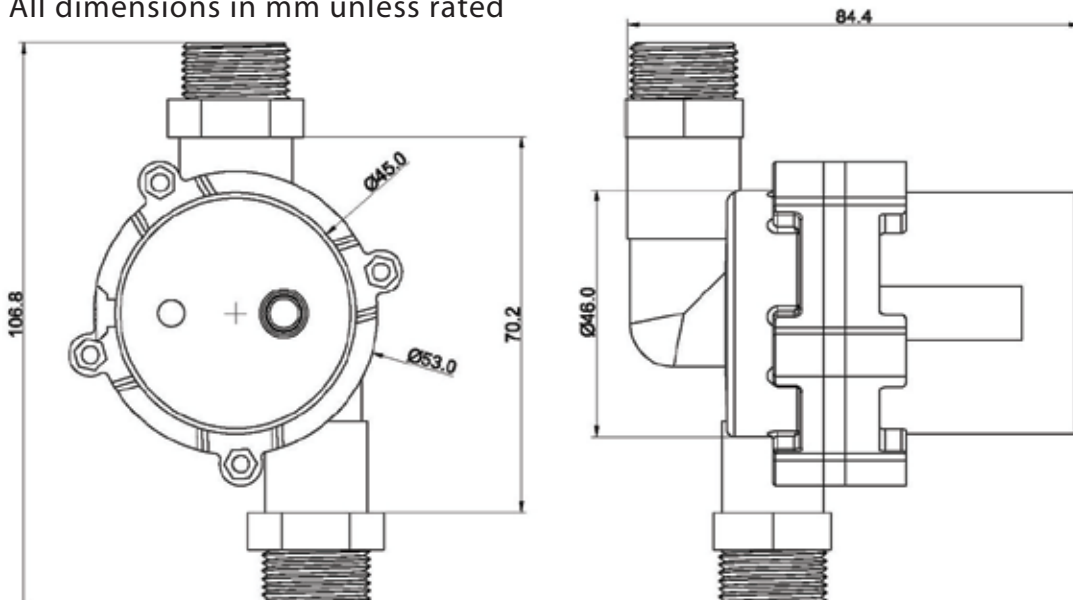

©2014 TEGpro www.tegpro.com.
Specifications subject to change without notice. Nov, 2014 - Rev 1.0